

Freestanding Home Safes + Wall Safes
Fire Protective Safes + Hotel Safes
High Quality Commercial Safes
Gun Cabinets
Disc Safes + Document Safes



safes



Commercial Freestanding Safes

MTD 34 - MTD 48 commercial freestanding safes "Diplomat"

RESISTANCE GRADE I



MTD 34 S

- type tested and supervised security by ECB-S
- protected against burglary and fire
- body double-walled, exterior walls with special armoring
- double-walled door, door leaf thickness 10 mm SM steel, door with double emergency locking system, not resettable, patented
- three-sided locking through strong square bolts, bolts with 2 integrated steel rolls each - double protection against flame-cutting, all-over gripping hinge
- prepared for both wall and floor fixing (MTD 46 and MTD 48 without floor fixing), with fixing material
- fire-protective material in body and door according to DIN 4102-A1, specially designed fire fold

- depth for files of common size, also available with interior safe
 - adjustable shelf (sizes 36 + 38 with 2 adjustable shelves)
 - Finishing: Silver metallic, special painting on request
- security advantage:**
- special protection against drilling in front of each bolt and in front of the lock
 - the models MTD 34 – MTD 48 are also available with left-sided hinge (except version C)

Left-hand-stop:

on demand without surcharge

MTD 34 - MTD 48 in versions S or E



MTD 35 C



Version S

Resettable, armoured high-security safe lock, "SecuSafe", ECB-S certified according to EN 1300 class B, with 2 keys, 10 levers, key captive, 50.000.000 key differs. More security in case of losing the key – immediately resettable to a new key. The locking armature protrudes 7 mm.

Detailed information regarding the resettable high security safe lock TRS 22 see p. 100.

Art.-No.	EAN	Exterior H x W x D	Interior H x W x D	Door H x W	Weight	Volume
	40 03482...	mm	mm	Opening mm	kg	l
MTD 34 S	10570 2	380 x 500 x 440	255 x 370 x 300	255 x 340	85	28,0
MTD 35 S	14000 0	470 x 500 x 440	345 x 370 x 300	345 x 340	100	38,0
MTD 36 S	10580 1	625 x 500 x 440	500 x 370 x 300	500 x 340	125	55,0
MTD 38 S	14280 6	985 x 500 x 440	860 x 370 x 300	860 x 340	175	94,2



MTD 38 C



Version C

With resettable combination lock "SecuMatic", ECB-S certified according to EN 1300 class B, with 1.000.000 different combinations possible, the locking armature protrudes 13 mm.

Art.-No.	EAN	Exterior H x W x D	Interior H x W x D	Door H x W	Weight	Volume
	40 03482...	mm	mm	Opening mm	kg	l
MTD 34 C	14010 9	380 x 500 x 440	255 x 370 x 300	255 x 340	85	28,0
MTD 35 C	14020 8	470 x 500 x 440	345 x 370 x 300	345 x 340	100	38,0
MTD 36 C	14030 7	625 x 500 x 440	500 x 370 x 300	500 x 340	125	55,0
MTD 38 C	14290 5	985 x 500 x 440	860 x 370 x 300	860 x 340	175	94,2

NEW: With integrated fingerscan-module in series. Detailed information about the biometric system see p. 99. Electronic combination lock "SecuTronic", VdS approved; ECB-S-certified according to EN 1300 class B. With intelligent menu-driven operation, administration of up to 10 user codes, up to 24 fingerscans and up to 300 optional TSE E-KEY. User names, access times and -rights, calendar functions, etc. via optional TSE PC-software packages programmable, see p. 29 + 31. Incl. 2 batteries Mignon LR 6 AA. The locking armature protrudes 32 mm.



Version E

Art.-No.	EAN	Exterior H x W x D	Interior H x W x D	Door H x W	Weight	Volume
	40 03482...	mm	mm	Opening mm	kg	l
MTD 34 E	14170 0	380 x 500 x 440	255 x 370 x 300	255 x 340	85	28,0
MTD 35 E	16580 5	470 x 500 x 440	345 x 370 x 300	345 x 340	100	38,0
MTD 36 E	14140 3	625 x 500 x 440	500 x 370 x 300	500 x 340	125	55,0
MTD 46 E	19440 9	737 x 500 x 440	500 x 370 x 300	500 x 340	155	55,0
MTD 38 E	16020 6	985 x 500 x 440	860 x 370 x 300	860 x 340	175	94,2
MTD 48 E	19450 8	1097 x 500 x 440	860 x 370 x 300	860 x 340	235	94,2

The BURG-WÄCHTER safes of this series comply to the specifications of the european norm EN 1143-1 and/or EN 1047-1. This is approved by the **ECB-S** certificates of the European Certification Board • Security systems (Certification authorities according to EN 45001). The **ECB-S** certification includes multiple unannounced inspections of the production sites. Hereby a constant quality level is guaranteed. Errors and omissions excepted.



Accessories

Art.-No.	EAN	
	40 03482...	
NRG 4	18280 2	Additional weight for MTD Diplomat – 1 set of NRG 4 up to 200 kg for MTD 46 – 2 sets of NRG 4 up to 300 kg for MTD 48
IT MTD	09960 5	interior safe for MTD 36 - 48 (H 180 x W 370 x D 260 mm)

Commercial Freestanding Safes



Information about Locking Systems



Version S: (from Resistance Grade 0)

- high-security safe lock "SecuSafe"
- ECB-S certified according to EN 1300 class B, for Resistance Grade N (0) to V, 10 levers, key captive, 50.000.000 different combinations
- more security in case of losing the key - immediately resettable to a new key
- resetting several safes to a common key is easily possible
- the innovative technology of these locks offers an extraordinary high protection against manipulation, strength against violent attacks and a maximum life



Version C: (MTD series)

- resettable, mechanical combination lock "SecuMatic", ECB-S certified according to EN 1300 class B
- digital combination lock - easy to handle, 1.000.000 different combinations possible
- resetting without any problem, digits engage perceptibly
- available for commercial freestanding safes series Diplomat



Version E: (from Resistance Grade 0)

NEW: With integrated fingerscan-module

- electronic combination lock "SecuTronic", VdS approved; ECB-S-certified EN 1300 class B incl. 2 batteries Mignon LR 6 AA
- 6-digit secret code, 1.000.000 differs
- intelligent menu-driven operation
- simple code change at any time
- up to 10 user codes, up to 24 fingerscans and up to 300 optional TSE E-KEYS can be administrated via key pad
- programming of user names, access times and -rights, calendar functions and the history file download via optional TSE software, see p. 29 + 31.
- with protection against manipulation
- batteries can be exchanged from outside
- no loss of memory without batteries
- detailed information about the biometric system see below



MTD 36 E



MTD 46 E



MTD 48 E

Biometric module for safes

Comfortable: Electronic lock "SecuTronic" including fingerprint-module

BURG-WÄCHTER for the first time produces safes including a biometric lock system. The opening of the safe via fingerscan will be very fast, comfortable and offers a secure authentication of the authorized persons.

The biometric system developed by BURG-WÄCHTER engineering will be alternatively used to the personal code. The electronic lock "SecuTronic" with fingerscan-module disposes of two selectable modes:

1. Certified mode

Safe opening via:

- Code entry
- TSE E-KEY
- Code entry + TSE E-KEY
- Code entry + Fingerscan
- TSE E-KEY + Fingerscan

2. Non certified mode

Safe opening via:

- Fingerscan
- all possibilities mentioned on the left side



The scanner disposes of a "fake finger detection" – this detection of living fingers excludes fake fingerprints to be identified. This precise and highly sensitive procedure of authentication operates with different dermal conditions, from extremely dry up to humid skin. Up to 24 different users can be scanned as authorized. The preventive programming of a second finger for every user will not be necessary as the biometrical system works redundant.

The official certification boards are currently developing test specifications for fingerscan systems. Therefore, a certification is not possible at the moment. Please agree the utilisation of the non certified mode with your property insurer when required.

Commercial freestanding safes

MTD 34 - 48

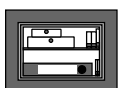

MTD 34

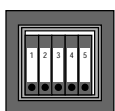

MTD 35



MTD 36
MTD 46

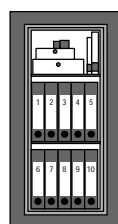

MTD 38
MTD 48

BURG-WÄCHTER safes correspond to the highest state-of-the-art technology and are internationally recognized. BURG-WÄCHTER is member of the VDMA security systems association and European Security Systems Association (ESSA e. V.) Changes in dimensions and constructions of wall safes and freestanding home safes can occur due to technical production changes.



Commercial Freestanding Safes



Security against flame cutting:
Body made of stainless steel!

MT 24 N - MT 26 N commercial freestanding safes „Karat“

RESISTANCE GRADE 0



MT 24 N S

- type tested and supervised security by ECB-S
- protected against burglary and fire
- body triple-walled, exterior walls of flame-cutting protected stainless steel material
- double-walled door with additional armoring, door leaf thickness 7 mm SM steel
- three-sided locking through strong square bolts, bolts on the top and on the bottom with integrated steel rolls - extreme protection against flame-cutting, drilling and attack, all-over gripping hinge
- prepared for both wall and floor fixing, with fixing material - extreme high breaking strength
- fire-protective material in body and door, specially designed fire fold
- depth for files of common size, 1 adjustable shelf

security advantage:

- special protection against drilling
- thermal emergency locking mechanism



Version S

Resettable, armoured high-security safe lock, "SecuSafe", ECB-S certified according to EN 1300 class B, with 2 keys, 10 levers, key captive, 50.000.000 key differs.

More security in case of losing the key – immediately resettable to a new key.

Detailed information regarding the resettable high security safe lock TRS 22 see below.

Art.-No.	EAN	Exterior H x W x D	Interior H x W x D	Door H x W	Weight	Volume
	40 03482...	mm	mm	Opening mm	kg	l
MT 24 N S	16050 3	340 x 430 x 390	250 x 348 x 294	250 x 336	43	25,8
MT 26 N S	19090 6	530 x 430 x 390	440 x 348 x 294	440 x 336	60	45,3



MT 26 N S

Key sets

Key sets	EAN	Key sets for high security safe lock TRS 22 VdS class 2
	40 03482...	
MT 24/26 N S	08890 6	Key set 55-2: two key set, length: 80 mm
MTD 34 - 36 S	08910 1	Key set 55-4: four key set, length: 80 mm
	06880 9	Key set 55-6: six key set, length: 80 mm

TRS 22 – The resettable high security safe lock

- Class B according to EN 1300
- 10 levers
- 50.000.000 keys to differ
- in case of loss a new key is programmable immediately
- immediate programming of keyed alike safes, if the customer e. g. buys an additional safe to be opened with the same key
- on request available with additional keys (without deliverytime)
- this lock is fitted in the following series:
 - MTD Diplomat
 - MT Karat & WT Karat (as from WT 14)
 - OL OfficeLine & OfficeDoku
 - High Quality Commercial Safes Royal
 - Safe-Dis 440 - 446



The BURG-WÄCHTER safes of this series comply to the specifications of the european norm EN 1143-1 and/or EN 1047-1. This is approved by the **ECB-S** certificates of the **European Certification Board • Security systems** (Certification authorities according to EN 45001). The **ECB-S** certification includes multiple unannounced inspections of the production sites. Hereby a constant quality level is guaranteed. Errors and omissions excepted.



BURG-WÄCHTER safes correspond to the highest state-of-the-art technology and are internationally recognized. BURG-WÄCHTER is member of the VDMA security systems association and European Security Systems Association (ESSA e. V.). Changes in dimensions and constructions of wall safes and freestanding home safes can occur due to technical production changes.

Commercial Freestanding Safes



RUSTPROOF
Rost-frei
Security against flame cutting:
Body made of stainless steel!

MT 24 N - MT 26 N commercial freestanding safes „Karat“

RESISTANCE GRADE 0

- type tested and supervised security by ECB-S
 - protected against burglary and fire
 - body triple-walled, exterior walls of flame-cutting protected stainless steel material
 - double-walled door with additional armouring, door leaf thickness 7 mm SM steel
 - three-sided locking through strong square bolts, bolts on the top and on the bottom with integrated steel rolls - extreme protection against flame-cutting, drilling and attack, all-over gripping hinge
 - prepared for both wall and floor fixing, with fixing material - extreme high breaking strength
 - fire-protective material in body and door, specially designed fire fold
 - depth for files of common size, 1 adjustable shelf
 - Finishing: Platinum grey
- security advantage:**
- special protection against drilling
 - thermal emergency locking mechanism



MT 24 N E



Version E

Electronic combination lock "SecuTronic", ECB-S certified according to EN 1300 class B, with intelligent menu-driven operation, administration of up to 10 users, 1.000.000 different combinations and up to 300 optional TSE E-KEY possible. User names, access times and -rights, calendar functions, etc. via optional TSE PC-software packages programmable, see p. 29 + 31. Incl. 2 batteries Mignon LR 6 AA. The locking armature protrudes 16 mm.

Art.-No.	EAN	Exterior H x W x D	Interior H x W x D	Door H x W	Weight	Volume
	40 03482...	mm	mm	Opening mm	kg	l
MT 24 N E	19150 7	340 x 430 x 390	250 x 348 x 294	250 x 336	43	25,8
MT 26 N E	19020 3	530 x 430 x 390	440 x 348 x 294	440 x 336	60	45,3



Version E FS

NEW: With integrated fingerscan-module in series. Detailed information about the biometric system see p. 99. Electronic combination lock "SecuTronic", VdS approved; ECB-S-certified according to EN 1300 class B. With intelligent menu-driven operation, administration of up to 10 user codes, up to 24 fingerscans and up to 300 optional TSE E-KEY. User names, access times and -rights, calendar functions, etc. via optional TSE PC-software packages programmable, see p. 29 + 31. Incl. 2 batteries Mignon LR 6 AA. The locking armature protrudes 32 mm.



Art.-No.	EAN	Exterior H x W x D	Interior H x W x D	Door H x W	Weight	Volume
	40 03482...	mm	mm	Öffnung mm	kg	l
MT 24 N E FS	32280 2	340 x 430 x 390	250 x 348 x 294	250 x 336	43	25,8
MT 26 N E FS	32290 1	530 x 430 x 390	440 x 348 x 294	440 x 336	60	45,3



MT 26 N E FS

Freestanding home safes

MT 24 N - MT 26 N

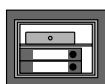

MT 24 N

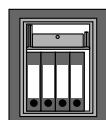

MT 26 N

The Karat safes can optionally be equipped with fingerscan lock technology:

The electronic combination safe lock "SecuTronic" is available as from resistance grade 0 optional in fingerprint version.





CL 10 - CL 40 Safety cabinets „Combi-Line“

SECURITY LEVEL S 2

FIRE RESISTANCE GRADE LFS 30 P

- The new BURG-WÄCHTER safety cabinets with a certification which is valid all over Europe. For the safe storage of documents, cash, jewellery, arms or ammunition, coins and valuables.
- Security Level S 2 according to DIN EN 14450
- Security Level B according to VDMA 24992, May 1995
- Fire Resistance LFS 30 P according to EN 15659 – 30 minutes fire protection for paper
- Fire-protective material according to DIN 4102
- Composite insulation in front of the door leaf as heat protection for the lock and bolts
- Tested and certified protection against burglary and fire
- Double-walled construction
- Internal hinge
- Lateral locking through strong round bolts of 25 mm Ø plus sliding bolt on the top
- All-over gripping rail on the hinge side
- prepared for both wall and floor fixing, with fixing material - extreme high breaking strength
- Colour: light grey
- Standard series with 1 shelf each



CL 10 S



Version S

Security safe lock "SecuSafe", VdS tested, ECB-S certified according to EN 1300 class A, 9 levers, more than 1.000.000 key differs



CL 20 S

Art.-No.	EAN	Exterior H x W x D	Interior H x W x D	Door H x W	Weight	Volume
	40 03482...	mm	mm	Opening mm	kg	l
CL 10 S	33400 3	320 x 435 x 380	205 x 320 x 232	205 x 265	44	15
CL 20 S	33420 1	360 x 495 x 445	245 x 380 x 297	245 x 325	55	27
CL 40 S	33440 9	560 x 495 x 445	445 x 380 x 297	445 x 325	77	50

Key blank for CL 10-40 S

Art.-No.	EAN	
	40 03482...	
Key blank 55	33610 6	Unit: 3 pcs.



CL 40 S



Technical novelty!
Sliding bolt on the top with additional protection against attack.

Safety cabinets Combi-Line



CL 10 - CL 40 Safety cabinets „Combi-Line“

SECURITY LEVEL S 2

FIRE RESISTANCE GRADE LFS 30 P

- The new BURG-WÄCHTER safety cabinets with a certification which is valid all over Europe. For the safe storage of documents, cash, jewellery, arms or ammunition, coins and valuables.
- Security Level S 2 according to DIN EN 14450
- Security Level B according to VDMA 24992, May 1995
- Fire Resistance LFS 30 P according to EN 15659 – 30 minutes fire protection for paper
- Fire-protective material according to DIN 4102
- Composite insulation in front of the door leaf as heat protection for the lock and bolts
- Tested and certified protection against burglary and fire
- Double-walled construction
- Internal hinge
- Lateral locking through strong round bolts of 25 mm Ø plus sliding bolt on the top
- All-over gripping rail on the hinge side
- prepared for both wall and floor fixing, with fixing material - extreme high breaking strength
- Colour: light grey
- Standard series with 1 shelf each



CL 10 E



Version E

Electronic combination lock "SecuTronic", VdS tested, ECB-S certified according to EN 1300 class B, 1.000.000 different combinations possible, incl. 3 batteries, type Micro LR 03 AAA.

Art.-No.	EAN	Exterior H x W x D	Interior H x W x D	Door H x W	Weight	Volume
	40 03482...	mm	mm	Opening mm		
CL 10 E	33410 2	320 x 435 x 380	205 x 320 x 232	205 x 265	44	15
CL 20 E	33430 0	360 x 495 x 445	245 x 380 x 297	245 x 325	55	27
CL 40 E	33450 8	560 x 495 x 445	445 x 380 x 297	445 x 325	77	50



CL 20 E

NEW! - 3 security standards in only one safe.

The safety cabinets Combi-Line correspond to 3 security standards:

- level B according to VDMA24992, 5/95
- level S 2 according to DIN EN 14450
- fire resistance LFS 30 P according to EN 15659 - 30 minutes fire protection for paper



CL 40 E

Subject to errors and changes.
Minor variations of sizes and weight depend on production characteristics.

Safety cabinets Combi-Line CL 10 - CL 40

CL 10

CL 20

CL 40



Freestanding Home Safes

Freestanding home safes CityLine

SECURITY LEVEL B

- security level B according to VDMA 24992, 5/95
- double-walled
- fire-protective material according to DIN 4102-A1
- prepared for both wall and floor fixing
- effective locking mechanism
- specially designed fire fold
- for files of common size



C 1 S

Freestanding home safes C 1 - C 4

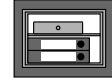

C 1

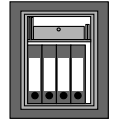

C 4



Version S

Security safe lock "SecuSafe", ECB-S certified according to EN 1300 class A, with 2 keys, 9 levers, more than 1.000.000 key differs.



C 1 E

Art.-No.	EAN	Exterior H x W x D	Interior H x W x D	Door H x W	Weight	Volume
	40 03482...	mm	mm	Opening mm	kg	l
C 1 S	14880 8	320 x 420 x 376	243 x 343 x 294	243 x 333	33,5	24,5
C 4 S	14070 3	528 x 435 x 382	440 x 350 x 292	440 x 345	49,0	45,3

Key blank for C 1-C 4 S, H 1 S

Art.-No.	EAN	
	40 03482...	
Key blank 51	16670 3	Unit: 3 pcs.



C 4 E



Version E

Electronic combination lock "SecuTronic", ECB-S certified according to EN 1300 class B, 1.000.000 different combinations possible, incl. batteries. The locking armature protrudes 13 mm.

Art.-No.	EAN	Exterior H x W x D	Interior H x W x D	Door H x W	Weight	Volume
	40 03482...	mm	mm	Opening mm	kg	l
C 1 E	26490 4	320 x 420 x 376	243 x 343 x 294	243 x 333	33,5	24,5
C 4 E	14080 2	528 x 435 x 382	440 x 350 x 292	440 x 345	49,0	45,3

Freestanding home safe HomeSafe H 1

SECURITY LEVEL B

- double-walled
- security level B according to VDMA 24992, 5/95
- with fire-protective material
- prepared for both wall and floor fixing
- for common files



H 1 S



Version S

Security safe lock "SecuSafe", ECB-S certified according to EN 1300 class A, with 2 keys, 9 levers, more than 1.000.000 key differs.

Art.-No.	EAN	Exterior H x W x D	Interior H x W x D	Door H x W	Weight	Volume
	40 03482...	mm	mm	Opening mm	kg	l
H 1 S	14900 3	320 x 420 x 376	243 x 343 x 294	243 x 333	33,5	24,5



H 1 E



Version E

Electronic combination lock "SecuTronic", ECB-S certified according to EN 1300 class B, 1.000.000 different combinations possible, incl. batteries. The locking armature protrudes 13 mm.

Art.-No.	EAN	Exterior H x W x D	Interior H x W x D	Door H x W	Weight	Volume
	40 03482...	mm	mm	Opening mm	kg	l
H 1 E	26290 0	320 x 420 x 376	243 x 343 x 294	243 x 333	33,5	24,5

BURG-WÄCHTER safes correspond to the highest state-of-the-art technology and are internationally recognized. BURG-WÄCHTER is member of the VDMA security systems association and European Security Systems Association (ESSA e. V.). Changes in dimensions and constructions of wall safes and freestanding home safes can occur due to technical production changes.

Freestanding Home Safes



Freestanding HomeSafe H3

SECURITY LEVEL A

- single walled home safe, compact - fits into every shelf
- because of its low weight of 16 kg it is also suitable for mobile use
- security level A according to VDMA 24992, 5/1995
- single walled
- double-walled door
- effective square bolt locking
- prepared for double wall fixing, with fixing material
- fits for A4 documents
- including 1 adjustable shelf
- colour: black



Version S

Security safe lock "SecuSafe", ECB-S certified according to EN 1300 class A, with 2 keys, 9 levers, more than 1.000.000 key differs.

Art.-No.	EAN	Exterior H x W x D	Interior H x W x D	Door H x W	Weight	Volume
	40 03482...	mm	mm	Opening mm	kg	l
H 3 S	25000 6	257 x 347 x 298	216 x 340 x 243	184 x 276	16,0	17,8



H 3 S



Version E

Electronic combination lock "SecuTronic", ECB-S certified according to EN 1300 class B, 1.000.000 different combinations possible, incl. batteries. The locking armature protrudes 13 mm.

Art.-No.	EAN	Exterior H x W x D	Interior H x W x D	Door H x W	Weight	Volume
	40 03482...	mm	mm	Opening mm	kg	l
H 3 E	25020 4	257 x 347 x 298	216 x 340 x 243	184 x 276	16,0	17,8



H 3 E

Freestanding home safe HomeSafe H 3 with slot

- with slot 230 x 8 mm
- security level B according to VDMA 24992, 5/95
- ideal for a safe and fast locking of banknotes or envelopes
- because of its low weight of 18 kg it is also suitable for the mobile use, i.e. events etc.
- colour: black
- other technical features see above
- **version S:** with safe lock, ECB-S certified according to EN 1300 class A, 9 levers, more than 1.000.000 key differs
- **version E:** with electronic combination lock SecuTronic (incl. batteries) ECB-S certified according to EN 1300 class B. The locking armature protrudes 9 mm.



H 3 E C4 EWS

Art.-No.	EAN	Exterior H x W x D	Interior H x W x D	Door H x W	Weight	Volume
	40 03482...	mm	mm	Opening mm	kg	l
H 3 S C4 EWS	26090 6	257 x 347 x 298	216 x 340 x 243	184 x 276	16,0	17,8
H 3 E C4 EWS	26190 3	257 x 347 x 298	216 x 340 x 243	184 x 276	16,0	17,8

Key blank for H 3 S

Art.-No.	EAN	
	40 03482...	
Key blank 51	16670 3	Unit: 3 pcs.

Freestanding home safes PointSafe P 1 - P 4

- tested in the BURG-WÄCHTER laboratory
- solid single-walled body
- double-walled door
- prepared for wall and floor fixing
- can be installed in cupboards, desks, etc.



P 2 S



Version S

with safe lock and 2 keys

Art.-No.	EAN	Exterior H x W x D	Interior H x W x D	Door H x W	Weight	Volume
	40 03482...	mm	mm	Opening mm	kg	l
P 1 S	24840 9	180 x 280 x 200	173 x 273 x 141	135 x 188	8,5	6,7
P 2 S	24850 8	255 x 350 x 300	248 x 343 x 241	188 x 230	16,5	20,5
P 3 S	24950 5	320 x 442 x 350	310 x 435 x 288	268 x 317	25,0	38,8

Key blank for P 1-P 3 S

Art.-No.	EAN	
	40 03482...	
Key blank 17 B	16810 3	Unit: 5 pcs.



P 3 E



Version E

with self-programmable electronic lock, battery operated (1,5 V Mignon), you can change your secret code at any time, with Master code - self programmable, no electrical supply necessary, additional lock for emergency opening, the locking armature protrudes 16 mm

Art.-No.	EAN	Exterior H x W x D	Interior H x W x D	Door H x W	Weight	Volume
	40 03482...	mm	mm	Opening mm	kg	l
P 1 E	26760 8	180 x 280 x 200	173 x 273 x 141	135 x 188	8,6	6,7
P 2 E	24810 2	255 x 350 x 300	248 x 343 x 241	188 x 230	16,5	20,5
P 3 E	24820 1	320 x 442 x 350	310 x 435 x 288	268 x 317	25,0	38,8
P 4 E	24830 0	500 x 416 x 350	490 x 410 x 288	423 x 290	33,0	57,9



P 4 E



Hotel safes

with self-programmable electronic lock,
Version KA1 and KA2 with keyed-alike emergency opening lock

Art.-No.	EAN	Exterior H x W x D	Interior H x W x D	Door H x W	Weight	Volume
	40 03482...	mm	mm	Opening mm	kg	l
P 1 E KA 1	29610 3	180 x 280 x 200	173 x 273 x 141	135 x 188	8,6	6,7
P 3 E KA 2	24790 7	320 x 442 x 350	310 x 435 x 288	268 x 317	25,0	38,8



P 1 E KA 1

The ideal safe for hotel use

- **Version KA1 and KA2:**
with keyed-alike emergency opening lock
- **For the Hotelier:**
superior hotel Master code for all safes - self programmable
- **For the hotel guest:**
easy and comprehensible short instructions

Laptop Safe, Fire protective safe



Point-Safe 3 E Laptop

- The new laptop safe with electronics
- Solid single-walled body
- Prepared for wall fixing
- Can be installed in cupboards, desks, etc.
- With self-programmable electronic combination lock
- For files and laptops



P 3 E Lap



Version E

With self-programmable electronic lock, you can change your secret code at any time, battery operated (incl. 4 batteries Mignon LR 6 AA), no electrical supply necessary, additional lock for emergency opening, the locking armature protrudes 16 mm.

Art.-No.	EAN	Exterior H x W x D	Interior H x W x D	Weight	Volume
	40 03482...	mm	mm	kg	l
Point 3 E Lap	18180 5	200 x 445 x 380	196 x 441 x 323	15,2	27,9

Fire protective safes

- Document safe – protection against burglary and fire
- Body and door double-walled
fully and massively filled with insulating concrete
- Door with double-sided locking
- Safe passed fire protection test successfully:
interior below 177° C after 1 hour – good protection for your documents
- Body with specially designed fire fold
- Prepared for floor fixing – incl. fixing material
- With modern, self-programmable electronic combination lock



- You can change your secret code at any time
- With user code and master code
- Battery operated (4 x 1,5 V Mignon)
- No electrical supply necessary
- Additional lock for emergency opening



FP 4 E

Art.-No.	EAN	Exterior H x W x D	Interior H x W x D	Weight	Volume
	40 03482...	mm	mm	kg	l
FP 4 E	20380 4	345 x 485 x 420	218 x 358 x 268	38,0	20,0

Smart Safe 2 E

- single-walled
- compact freestanding home safe
- with resettable electronic lock
- overriding emergency lock

Art.-No.	EAN	Exterior H x W x D	Interior H x W x D	Weight	Volume
	40 03482...	mm	mm	kg	l
SMART 2E	22020 7	260 x 350 x 280	254 x 344 x 218	11,2	19,0



Smart 2E

Basic Safe 1E

- single-walled
- compact freestanding home safe
- with resettable electronic lock
- overriding emergency lock

Art.-No.	EAN	Exterior H x W x D	Interior H x W x D	Weight	Volume
	40 03482...	mm	mm	kg	l
BASIC 1E	26780 6	200 x 300 x 210	195 x 295 x 143	6,7	8,2



Basic 1E

Universal Safe 2E

- single-walled
- compact freestanding home safe
- with resettable electronic lock
- overriding emergency lock

Art.-No.	EAN	Exterior H x W x D	Interior H x W x D	Weight	Volume
	40 03482...	mm	mm	kg	l
UNI 2E	21040 6	260 x 350 x 260	256 x 346 x 210	11,0	18,6



Universal 2E

Subject to errors and changes. Minor variations of sizes and weight depend on production characteristics.



Wall safes Diplomat



WT 10/6 350 E

Wall safes WT 10 „Diplomat“

RESISTANCE GRADE I

- type tested and supervised security by ECB-S
- back wall from 10 mm strong steel construction with stainless steel proportion as flame-cutting protection; more security – less installation depth
- double-walled door
- door with double emergency locking mechanism, not resettable, patented
- three-sided locking through strong square bolts, bolts with 2 integrated steel rolls each, double protection against flame-cutting
- all-over gripping hinge
- locking mechanism with special protection against penetration
- door with fire-protective material according to DIN 4102-A1
- specially designed fire fold
- also available with left-sided hinge
- sufficient space for files of common size
- WT 10 sizes 6 and 8 with 2 shelves in series
- two-coloured



WT 10/6 580 E



Version E

NEW: With integrated fingerscan-module in series. Detailed information about the biometric system see p. 99. Electronic combination lock "SecuTronic", VdS approved; ECB-S-certified according to EN 1300 class B. With intelligent menu-driven operation, administration of up to 10 user codes, up to 24 fingerscans and up to 300 optional TSE E-KEY. User names, access times and -rights, calendar functions, etc. via optional TSE PC-software packages programmable, see p. 29 + 31. Incl. 2 batteries Mignon LR 6 AA. The locking armature protrudes 32 mm.



Art.-No.	EAN	Exterior H x W x D	Interior H x W x D	Door H x W	Weight	Volume
		mm	mm	Opening mm		
WT 10/5 350 E	21580 7	465 x 500 x 385	345 x 370 x 300	345 x 340	61	37,8
WT 10/6 350 E	21640 8	620 x 500 x 385	500 x 370 x 300	500 x 340	80	54,8
WT 10/6 580 E	21790 0	620 x 500 x 580	500 x 370 x 495	500 x 340	89	90,3
WT 10/8 350 E	21700 9	980 x 500 x 385	860 x 370 x 300	860 x 340	115	94,2
WT 10/8 580 E	21820 4	980 x 500 x 580	860 x 370 x 495	860 x 340	115	155,4

IT WT 10 09960 5 Interior safe for WT 10 for files (dimensions: H 180, W 370, D 260 mm)

Optimal utilization of the interior of BURG-WÄCHTER wall safes:

CityLine:

CW 5/350

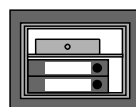

Series WT Karat with full depth:

WT 14 N

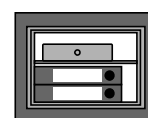

WT 16 N

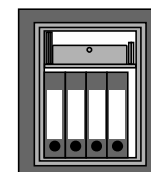

Series WT 10 Diplomat:

10/5 350

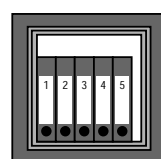

10/6 350
10/6 580

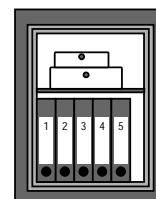

10/8 350
10/8 580

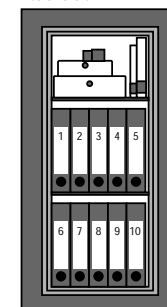

The BURG-WÄCHTER safes of this series comply to the specifications of the european norm EN 1143-1 and/or EN 1047-1. This is approved by the **ECB-S** certificates of the **European Certification Board • Security systems** (Certification authorities according to EN 45001). The **ECB-S** certification includes multiple unannounced inspections of the production sites. Hereby a constant quality level is guaranteed. Errors and omissions excepted.



BURG-WÄCHTER safes correspond to the highest state-of-the-art technology and are internationally recognized. BURG-WÄCHTER is member of the VDMA security systems association and European Security Systems Association (ESSA e. V.). Changes in dimensions and constructions of wall safes and freestanding home safes can occur due to technical production changes.

Wall safes Karat



Wall safes WT 11 - WT 13 „Karat“

- security level B according to VDMA 24992, 5/95
- the series of wall safes with variable depth – optimal utilization of space through to the adjustable body
- door double walled
- door leaf of 7 mm SM steel

SECURITY LEVEL B

- solid locking through square bolts
- all-over gripping hinge
- door with fire-protective material according to DIN 4102-A1
- specially designed fire fold



Version S

Security safe lock "SecuSafe", ECB-S certified according to EN 1300 class A, with 2 keys, 9 levers, more than 1.000.000 key differs.

Art.-No.	EAN	Exterior H x W x D	Interior H x W x D	Door H x W	Weight	Volume
	40 03482...	mm	mm	Opening mm	kg	l
WT 11 S	27800 0	170 x 240 x 119 -163	110 x 190 x 74,5 -118,5	110 x 130	7,5	1,55 -2,4
WT 12 S	27810 9	205 x 290 x 119 -163	145 x 240 x 74,5 -118,5	145 x 190	10,2	2,6 -4,1
WT 13 S	27830 7	250 x 350 x 233 -351	190 x 300 x 188,5 -306,5	190 x 251	18,0	10,7 -17,4



WT 12 S



Version E

Electronic combination lock "SecuTronic", ECB-S certified according to EN 1300 class B, 1.000.000 different combinations possible, incl. batteries. The locking armature protrudes 13 mm.

Art.-No.	EAN	Exterior H x W x D	Interior H x W x D	Door H x W	Weight	Volume
	40 03482...	mm	mm	Opening mm	kg	l
WT 13 E	27820 8	250 x 350 x 233 -351	190 x 300 x 188,5 -306,5	190 x 251	18,0	10,7 -17,4



WT 14 N E

Wall safes WT 14 N - WT 16 N „Karat“

- type tested and supervised security by ECB-S!
- the wall safe series with variable depth – optimal utilization of space through to the adjustable body
- sufficient space for files of common size when completely pulled out
- exterior frame of flame-cutting protected stainless steel material
- door double walled, with additional armoring
- three-sided locking, bolts on the top and on the bottom

RESISTANCE GRADE 0

- with integrated steel rolls
- extreme protection against flame-cutting, drilling and attack
- all-over gripping hinge
- door with fire-protective material
- specially designed fire fold

security advantage:

- special protection against drilling
- thermal emergency locking mechanism



Version S

Resettable, armoured high-security safe lock "SecuSafe", ECB-S certified according to EN 1300 class B, with 2 keys, 10 levers, key captive, 50.000.000 key differs.

More security in case of losing the key – immediately resettable to a new key.

Detailed information regarding the resettable high security safe lock TRS 22 see p. 100.

Art.-No.	EAN	Exterior H x W x D	Interior H x W x D	Door H x W	Weight	Volume
	40 03482...	mm	mm	Opening mm	kg	l
WT 14 N S	28340 0	342 x 434 x 233 -351	250 x 352 x 178 -296	250 x 336	27,5	15,6 -26,0
WT 16 N S	28360 8	532 x 434 x 233 -351	440 x 352 x 178 -296	440 x 336	39,0	27,5 -45,7



WT 16 N S



Version E*

Electronic combination lock "SecuTronic", ECB-S certified according to EN 1300 class B, with intelligent menu-driven operation, administration of up to 10 users, 1.000.000 different combinations and up to 300 optional TSE E-KEY possible. User names, access times and -rights, calendar functions, etc. via optional TSE PC-software packages programmable, see p. 29 + 31. Incl. 2 batteries Mignon LR 6 AA. The locking armature protrudes 16 mm.

Art.-No.	EAN	Exterior H x W x D	Interior H x W x D	Door H x W	Weight	Volume
	40 03482...	mm	mm	Opening mm	kg	l
WT 14 N E	28350 9	342 x 434 x 233 -351	250 x 352 x 178 -296	250 x 336	27,5	15,6 -26,0
WT 16 N E	28380 6	532 x 434 x 233 -351	440 x 352 x 178 -296	440 x 336	39,0	27,5 -45,7

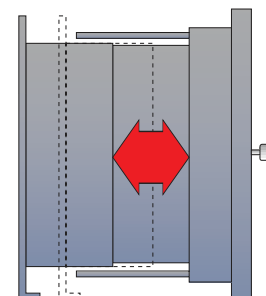

Tip: variable depth for an optimal utilisation of the interior space according to the wall thickness



* Optional available with fingerscan module. Details of the biometric system see page 99.

The best solution for maximizing the interior space: variable depth, adjustable safe body (see sketch on the right). Pull-out shelves adapt themselves individually to every depth (WT 14/16 for files of common size when completely pulled out).



Wall safes CityLine, PointSafe



CW 5 350 S

Wall safe CityLine CW 5

SECURITY LEVEL B

- security level B according to VDMA 24992, 5/95
- double-walled door
- locking through round dog bolts
- door with fire-protective material according to DIN 4102-A1
- specially designed fire fold
- sufficient space for files of common size



Version S

Security safe lock "SecuSafe", ECB-S certified according to EN 1300 class A, with 2 keys, 9 levers, more than 1.000.000 key differs.

Art.-No.	EAN	Exterior H x W x D	Interior H x W x D	Door H x W	Weight	Volume
	40 03482...	mm	mm	Opening mm	kg	l
CW 5 350 S	15030 6	326 x 440 x 350	243 x 343 x 294	251 x 333	19,5	24,5



PW 1 S

Wall safes PointSafe PW 1 - PW 3

- tested in the BURG-WÄCHTER laboratory
- solid single-walled body
- with security safe lock
- with 2 keys



Version S

with safe lock and 2 keys

Art.-No.	EAN	Exterior H x W x D	Interior H x W x D	Weight	Volume
	40 03482...	mm	mm	kg	l
PW 1 S	24900 0	180 x 260 x 148	150 x 230 x 100	6,8	3,5
PW 2 S	24860 7	220 x 340 x 140	177 x 298 x 85	10,2	4,5
PW 3 S	24870 6	260 x 390 x 195	213 x 345 x 140	15,0	10,3



PW 2 S



Version E

with self-programmable electronic lock, battery operated (1,5 V Mignon), you can change your secret code at any time, with Master code - self programmable, no electrical supply necessary, additional lock for emergency opening, the locking armature protrudes 16 mm

Art.-No.	EAN	Exterior H x W x D	Interior H x W x D	Weight	Volume
	40 03482...	mm	mm	kg	l
PW 2 E	24960 4	220 x 340 x 140	177 x 298 x 85	10,2	4,5
PW 3 E	24970 3	260 x 390 x 195	213 x 345 x 140	14,8	10,3



PW 2 E



PW 3 S



PW 3 E

Important built-in recommendations for wall safes:

- When having unpacked your new safe please check its perfect function.
- For your own security remove all batteries from the front blind by E-Version.
- After having finished all works do not place the batteries until there is no humidity left in the surrounding of the safe.
- Thus, you protect yourself against any short-circuit damages due to humidity and prevent a new coding by unauthorized persons.
- Prepare wall opening according to explanation mentioned below.
- Wall opening has to be big enough that the safe is surrounded with concrete of at least 100 mm on all sides.
- Cover safe front well with foil and stick them together.
- Insert the safe perpendicularly into the opening and wedge it (**consider imprint „oben“**), control with spirit level.
- Concrete B 45, mixture 1:4, put in and compress, mixture not too wet.
- Open safe door after approx. 2 days after setting in concrete, wipe out moisture remainings and let it dry.
- Because of security reasons safes and keys are not numbered. Spare keys can only be produced against presentation of a sample.
- Safe locks should not be oiled.
- If you have a safe with combination lock you should deposit your secret number safely.

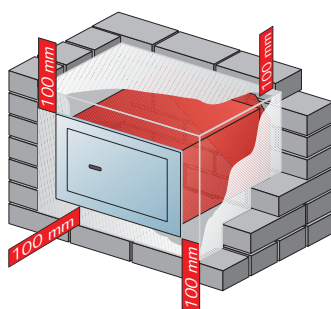

Please note:

An installation into exterior walls can cause condensation water due to temperature differences. Then the safe has to be insulated. Failures due to condensation water or improper installation are at owner's risk.



Gun owners bear a high responsibility!

The basic rule of the German law on arms § 36 (1):

The owner of arms or ammunition has to take precautions to avoid theft or unauthorized third persons taking them.

Guideline for the safe storage of arms and/or ammunition

To avoid the probability of misusing of arms and to protect your valuable arms against theft a high quality gun cabinet is recommended.

Must buy:

Ranger I / 8 * Resistance grade I - your safe choice!

In relation to the value of your fire arms this safe is a wise investment.

Not only your fire arms are protected but also the ammunition and many more.

Leading criminologists recommend safes with digital locks because of the security gap caused by the spare key.





**BURG
WÄCHTER**

Gun cabinets

NEW

Ranger I/8

RESISTANCE GRADE I

- Type tested and supervised security by the ECB-S/VdS
- Protection against burglary and fire
- Body double-walled
- Door double-walled
- Solid 3-sided locking through round bolts of Ø 28 mm

- Additional round dog bolts on the hinge side
- Prepared for floor fixing, with fixing material
- **Security advantage:** includes non resettable emergency locking system



Ranger I/8



Version S

Resettable, armoured high-security safe lock, "SecuSafe", ECB-S certified according to EN 1300 class B, with 2 keys, 10 levers, key captive, 50.000.000 key differs.

More security in case of losing the key – immediately resettable to a new key.

Detailed information regarding the resettable high security safe lock TRS 22 see p. 100.

Art.-No.	for rifles	EAN	Exterior H x W x D	Weight
		40 03482...	mm	kg
Ranger I/8 S	8	32260 4	1486 x 641 x 554	265



Ranger I/8



Version E

Electronic combination lock "SecuTronic", ECB-S certified according to EN 1300 class B, 1.000.000 different combinations possible, incl. batteries. The locking armature protrudes 50 mm.

Art.-No.	for rifles	EAN	Exterior H x W x D	Weight
		40 03482...	mm	kg
Ranger I/8 E	8	32270 3	1486 x 641 x 554	265



Ranger I/8 S

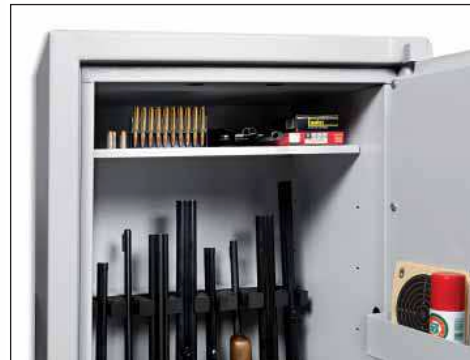

According to
§ 36
of the current
German law
on arms

According to § 36 of the current German law on arms, 04/2009. BURG-WÄCHTER recommends the Ranger I/8 gun safes for the safe keeping of **handguns and ammunition.**



Ranger I/8 E

BURG-WÄCHTER safes correspond to the highest state-of-the-art technology and are internationally recognized. BURG-WÄCHTER is member of the VDMA security systems association and European Security Systems Association (ESSA e. V.). Changes in dimensions and constructions of wall safes and freestanding home safes can occur due to technical production changes.

Gun cabinets



Ranger A 5

SECURITY LEVEL A

Single-walled gun cabinet for 5 rifles

- light height: 1250 mm
- security level A according to VDMA 24992, 5/95
- with lockable interior compartment and brackets at the inner side of the door
- double-walled door, 60 mm
- body of 3 mm steel with specially designed fire fold

- three-sided locking through strong round bolts
- prepared for wall and floor fixing
- high-quality workmanship
- German Technology
- tested in the BURG-WÄCHTER laboratory



Version S

Security safe lock "SecuSafe", ECB-S certified according to EN 1300 class A, with 2 keys, 9 levers, more than 1.000.000 key differs.

Art.-No.	for rifles	EAN	Exterior H x W x D	Weight
		40 03482...	mm	kg
A 5 S	5	02970 1	1450 x 300 x 335	64



Version E

Electronic combination lock "SecuTronic", ECB-S certified according to EN 1300 class B, 1.000.000 different combinations possible, incl. batteries. The locking armature protrudes 13 mm.

Art.-No.	for rifles	EAN	Exterior H x W x D	Weight
		40 03482...	mm	kg
A 5 E	5	34250 3	1450 x 300 x 335	64



Ranger A 5

Ranger W 7 A/B

SECURITY LEVEL A / Interior compartment SECURITY LEVEL B

Single-walled gun cabinet for 7 rifles

- light height: 1220 mm
- security level A according to VDMA 24992, 5/95
- double-walled door, 60 mm
- body of 3 mm steel with specially designed fire fold
- three-sided locking through strong round bolts
- prepared for wall and floor fixing

- **Lockable interior compartment, double walled,** for common storage of weapons and ammunition security grade B according to the VDMA 24992 - 5/95
- high-quality workmanship
- German Technology
- tested in the BURG-WÄCHTER laboratory



Version S

Security safe lock "SecuSafe", ECB-S certified according to EN 1300 class A, with 2 keys, 9 levers, more than 1.000.000 key differs.

Art.-No.	for rifles	EAN	Exterior H x W x D	Weight
		40 03482...	mm	kg
W 7 A/B S	7	29980 7	1450 x 400 x 335	76



Version E

Electronic combination lock "SecuTronic", ECB-S certified according to EN 1300 class B, 1.000.000 different combinations possible, incl. batteries. The locking armature protrudes 13 mm.

Art.-No.	for rifles	EAN	Exterior H x W x D	Weight
		40 03482...	mm	kg
W 7 A/B E	7	34260 2	1450 x 400 x 335	76



Ranger W 7 A/B

Key blanks for Ranger A 5/W 7

Art.-No.	EAN	Unit
	40 03482...	
Key blank 51	16670 3	Unit: 3 pcs.

BURG-WÄCHTER safes correspond to the highest state-of-the-art technology and are internationally recognized. BURG-WÄCHTER is member of the VDMA security systems association and European Security Systems Association (ESSA e. V.). Changes in dimensions and constructions of wall safes and freestanding home safes can occur due to technical production changes.



High Quality Commercial Safes

Security characteristics of the series ROYAL

- type tested and supervised security by ECB-S
- body triple-walled
- concealed hinges
- armoured bolt system
- three-sided locking through strong square bolts
- all-over gripping hinge
- locking mechanism with special protection against penetration
- the locking armature handle protrudes 65 mm
- fire protective material according to DIN 4102-A1
- specially designed, doubled fire fold
- prepared for quadro wall fixing, incl. fixing material
- interior with sufficient space for files of common size
- special equipment and accessories see page 117
- standard painting: grey/white
special paintwork see page 117
- recommendation for more security:
combine two locking systems with each other
For all possible combinations see page 116.



E 514 E
Special paintwork Brilliant

Locking system "SecuTronic":

BURG-WÄCHTER recommends the electronic locking system 'SecuTronic.' For more security and comfort.

- according to EN 1300: lock class B or D
- Intelligent, menu-driven operation
- depending on the security level up to 10 or 34 users can be administered
- 1.000.000 different combinations possible



Version E



Version EE



Fingerscan-Module in series.
Details see page 99.

ROYAL E 512 - 518

RESISTANCE GRADE I

Standard locking system:

- resettable, armoured high-security safe lock 'SecuSafe', ECB-S certified according to EN 1300 class B
- more security in case of losing the key – immediately resettable to a new key
- 10 levers, key captive

- 50.000.000 key differs

More security:

- isolating material according to DIN 4102-B2
- emergency locking mechanism, not resettable



E 524 S

Art.-No.	EAN	Exterior H x W x D	Interior H x W x D	Weight	Volume
	40 03482...	mm	mm	kg	l
E 512 S	25400 4	1000 x 695 x 635	745 x 545 x 400	220	162
E 514 S	25500 1	1315 x 695 x 635	1060 x 545 x 400	305	231
E 516 S	25600 8	1755 x 695 x 635	1500 x 545 x 400	350	327
E 518 S	20740 6	1755 x 1130 x 635	1500 x 980 x 400	500	588



E 512 E - E 518 E
Fingerscan-Module in series.

ROYAL E 522 - 528

RESISTANCE GRADE II

Standard locking system:

- resettable, armoured high-security safe lock 'SecuSafe', ECB-S certified according to EN 1300 class B
- more security in case of losing the key – immediately resettable to a new key
- 10 levers, key captive

- 50.000.000 key differs

More security:

- isolating material according to DIN 4102-B2
- emergency locking mechanism, not resettable

Art.-No.	EAN	Exterior H x W x D	Interior H x W x D	Weight	Volume
	40 03482...	mm	mm	kg	l
E 522 S	25900 9	1000 x 695 x 635	745 x 545 x 400	360	162
E 524 S	26000 5	1315 x 695 x 635	1060 x 545 x 400	480	231
E 526 S	26100 2	1755 x 695 x 635	1500 x 545 x 400	640	327
E 528 S	20950 9	1755 x 1130 x 635	1500 x 980 x 400	910	588



E 522 E - E 528 E
Fingerscan-Module in series.

The BURG-WÄCHTER safes of this series comply to the specifications of the european norm EN 1143-1 and/or EN 1047-1. This is approved by the **ECB-S** certificates of the European Certification Board • Security systems (Certification authorities according to EN 45001). The **ECB-S** certification includes multiple unannounced inspections of the production sites. Hereby a constant quality level is guaranteed. Errors and omissions excepted.



High Quality Commercial Safes



ROYAL E 532 - 538

RESISTANCE GRADE III

Standard locking system:

- resettable, armoured high-security twin tumbler lock, 'SecuSafe', ECB-S certified according to EN 1300 class B
- more security in case of losing the key – immediately resettable to a new key
- 10 levers, key captive
- 50.000.000 key differs
- three sided locking with double strong square bolts on the top and the bottom of the door.

More security:

- fire-protective material (special armour-mass) according to DIN 4102-A1
- emergency locking mechanism, not resettable
- prepared for VdS approved alarm systems

Art.-No.	EAN	Exterior H x W x D	Interior H x W x D	Weight	Volume
	40 03482...	mm	mm	kg	l
E 532 S	26400 3	1000 x 695 x 635	745 x 545 x 400	540	162
E 534 S	26500 0	1315 x 695 x 635	1060 x 545 x 400	690	231
E 536 S	26600 7	1755 x 695 x 635	1500 x 545 x 400	900	327
E 538 S	21830 3	1755 x 1130 x 635	1500 x 980 x 400	1280	588



E 532 E



E 532 E - E 538 E
Fingerscan-Module in series.

ROYAL E 542 - 548

RESISTANCE GRADE IV

Standard locking system:

- two resettable, armoured high-security twin tumbler locks, 'SecuSafe', ECB-S certified according to EN 1300 class B
- more security in case of losing the key – immediately resettable to a new key
- 10 levers, key captive
- 50.000.000 key differs
- three sided locking with double strong square bolts on the top and the bottom of the door.

More security:

- fire-protective material (special armour-mass) according to DIN 4102-A1
- double emergency locking mechanism, not resettable
- generally with 2 locking systems
- prepared for VdS approved alarm systems

Art.-No.	EAN	Exterior H x W x D	Interior H x W x D	Weight	Volume
	40 03482...	mm	mm	kg	l
E 542 SS	26900 8	1000 x 695 x 635	745 x 545 x 400	560	162
E 544 SS	27000 4	1315 x 695 x 635	1060 x 545 x 400	720	231
E 546 SS	27100 1	1755 x 695 x 635	1500 x 545 x 400	940	327
E 548 SS	23090 9	1755 x 1130 x 635	1500 x 980 x 400	1340	588



E 546 ES



E 542 EE - E 548 EE
Fingerscan-Module in series.

ROYAL E 552 - 558

RESISTANCE GRADE V

Standard locking system:

- two resettable, armoured high-security twin tumbler locks, 'SecuSafe', ECB-S certified according to EN 1300 class B
- more security in case of losing the key – immediately resettable to a new key
- 10 levers, key captive
- 50.000.000 key differs
- three sided locking with double strong square bolts on the top and the bottom of the door.

More security:

- fire-protective material (special armour-mass) according to DIN 4102-A1
- double emergency locking mechanism, not resettable
- generally with 2 locking systems
- additional armouring in front of and behind the locking system
- special double armouring in body and door
- prepared for VdS approved alarm systems

Art.-No.	EAN	Exterior H x W x D	Interior H x W x D	Weight	Volume
	40 03482...	mm	mm	kg	l
E 552 SS	24550 7	1040 x 735 x 680	745 x 545 x 400	980	162
E 554 SS	24600 9	1355 x 735 x 680	1060 x 545 x 400	1250	231
E 556 SS	25090 7	1795 x 735 x 680	1500 x 545 x 400	1650	327
E 558 SS	25470 7	1795 x 1170 x 680	1500 x 980 x 400	2300	588



E 552 EE - E 558 EE
Fingerscan-Module in series.

Locking systems for ROYAL according to VdS Safelock listing 2323



Version S



Version SS



Version C



Version CS



Version CC



Version E



Version ES



Version EE



Version HSS



Version HSE



Version HEE

Version	Lock class	Description
EN 1300		
Series E 512 - 538:		
S	B	1 high-security safe lock, standard fitting
SS	B	2 high-security safe locks
C	B	1 manipulation-protected, resettable combination lock instead of the safe lock
CS	B	1 manipulation-protected, resettable combination lock and a high-security safe lock
CC	B	2 manipulation-protected, resettable combination locks
E	B	1 electronic combination lock instead of the high-security safe lock
ES	B	1 electronic combination lock and a safe lock
EE	B	2 electronic combination locks
Series E 542 - 558:		
SS	B	2 high-security safe locks
CS	B	1 manipulation-protected, resettable combination lock and a high-security safe lock
ER S	B	1 redundant electronic combination lock and 1 high-security safe lock
ER ER	B	2 redundant electronic combination locks
High-tech locking systems for much more security:		
HSS	C	2 high-security safe locks
HSE	C/D	1 high-security safe lock and 1 high-security electronic combination lock
HEE	D	2 high-security electronic combination locks

BURG-WÄCHTER safe locks class D according to EN 1300 contain a redundant system for the high security sector. The keyboard with display operation is integrated in the turning knob. The strongly illuminated display disposes of a special protection which prevents third persons from viewing the display from the side.

The high security locks HEE are approved by the German federal office for IT-security, the high quality commercial safes E 542 - 558 are equipped with redundant locks as a standard.

Key sets for Royal

Detailed information regarding the resettable high security safe lock TRS 22 see p. 100.

Art.-No.	EAN	
	40 03482...	
Key set 55 GLK-2	09270 5	two key set, length: 162 mm, incl. hinge
Key set 55 GLK-4	09290 3	four key set, length: 162 mm, incl. hinge
Key set 55 GLK-6	06900 4	six key set, length: 162 mm, incl. hinge

High Quality Commercial Safes ROYAL sizes 2 - 8

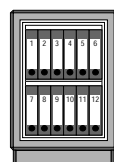

size 2

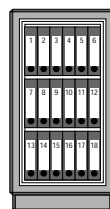

size 4

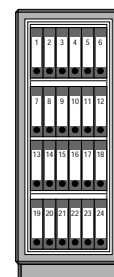

size 6

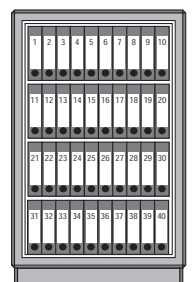

size 8

High quality commercial safes ROYAL E with fingerscan-module in series.

Details see page 99.



Special paintwork on request

Art.-No.
RAL paintwork
Brilliant paintwork
Brilliant paintwork: for accessories (interior safe, etc.)

Special fittings on request

Description
Bolt and handle gold-plated
Bolt and handle and 1 armature gold-plated (except E)
Bolt and handle and 2 armatures gold-plated (except E)
Handle chromium-plated or varnished
Handle and 1 armature chromium-plated or varnished
Handle and 2 armatures chromium-plated or varnished
Front blind with RAL paintwork
Front blind with metallic paintwork
Front blind with brilliant paintwork
Front blind gold- chromium- or brass-plated

Accessories ROYAL E 512 - 558

Art.-No.	EAN	Description
	40 03482...	for ROYAL sizes 2 - 6:
IT 1 ZS mont.	15240 9	Interior safe with cylinder lock – 250 mm high (inside 210 mm)
IT 2 TR mont.	15250 8	Interior safe with safe lock – 405 mm high (inside 365 mm for files)
FB 36	15350 5	Additional shelf
A-FB 510	15360 4	Pull-out shelf
A-HR 510	15370 3	Telescopic pull-out hanging frame
N R G 500 - 3	15210 2	Additional weight
		for ROYAL size 8:
IT 2 TR mont.	15250 8	Interior safe with twin tumbler lock – 405 mm high (inside 365 mm)
FB 37	07460 2	Additional shelf
A-FB 517	05190 0	Pull-out shelf
A-HR 517	05180 1	Telescopic pull-out hanging frame



Interior safe IT 1



Interior safe IT 2



A-HR 510



Special solutions for professional demands:
Ask our safe specialists for the perfect solution of
your security demands.

Office Line 101 - 106

SECURITY LEVEL B

- safety cabinet/commercial freestanding safe
- security level B according to VDMA 24992, 5/95
- body double-walled
- door double-walled
- solid three-sided locking through round bolts of 28 mm Ø, additional round dog bolts on hinge side
- prepared for floor fixing with fixing material
- depth for files of common size, adjustable shelves, also available with interior safe
- standard series version painted light grey RAL 7035, armature black



Office 101 S



Version S

Resettable, armoured high-security safe lock, "SecuSafe", ECB-S certified according to EN 1300 class B, with 2 keys, 10 levers, key captive, 50.000.000 key differs. The locking armature protrudes 20 mm. More security in case of losing the key – immediately resettable to a new key.

Detailed information regarding the resettable high security safe lock TRS 22 see p. 100.

Art.-No.	EAN	Exterior H x W x D	Interior H x W x D	Door H x W	Weight	Volume
	40 03482...	mm	mm	Opening mm	kg	l
Office 101 S	30610 9	626 x 641 x 554	476 x 498 x 370	476 x 498	110	87
Office 102 S	30630 7	816 x 641 x 554	666 x 498 x 370	666 x 498	126	122
Office 102 S 300	30850 9	816 x 641 x 554	666 x 498 x 370	666 x 498	300	122
Office 104 S	30650 5	1096 x 641 x 554	946 x 498 x 370	946 x 498	163	174
Office 104 S 300	30870 7	1096 x 641 x 554	946 x 498 x 370	946 x 498	300	174
Office 106 S	30840 0	1486 x 780 x 554	1336 x 638 x 370	1336 x 638	300	315



Version E

Electronic combination lock "SecuTronic", ECB-S certified according to EN 1300 class B, 1.000.000 different combinations possible, incl. batteries. The locking armature protrudes 50 mm.

Art.-No.	EAN	Exterior H x W x D	Interior H x W x D	Door H x W	Weight	Volume
	40 03482...	mm	mm	Opening mm	kg	l
Office 101 E	30600 0	626 x 641 x 554	476 x 498 x 370	476 x 498	110	87
Office 102 E	30620 8	816 x 641 x 554	666 x 498 x 370	666 x 498	126	122
Office 102 E 300	30860 8	816 x 641 x 554	666 x 498 x 370	666 x 498	300	122
Office 104 E	30640 6	1096 x 641 x 554	946 x 498 x 370	946 x 498	163	174
Office 104 E 300	30880 6	1096 x 641 x 554	946 x 498 x 370	946 x 498	300	174
Office 106 E	30890 5	1486 x 780 x 554	1336 x 638 x 370	1336 x 638	300	315



Office 102 E

Interior safe for Office 101 - 106

It is also possible to assemble various interior safes one below the other.

Art.-No.	EAN	suitable for:	H x W x D
	40 03482...		mm
IT - Office 1	15230 0	Office 101 -104/300	151 x 498 x 303
IT - Office 2	15320 8	Office 106	151 x 638 x 303

Practical accessories for Office 101 - 104

Art.-No.	EAN	suitable for:	
	40 03482...		
A-FB 100	04540 4	Office 101 -104/300	pull-out shelf Office
A-HR 100	04680 7	Office 101 -104/300	pull-out hanging frame Office

Key sets for OL 101-126

Detailed information regarding the resettable high security safe lock TRS 22 see p. 100.

Art.-No.	EAN	
	40 03482...	
Key set 55 OL-2	08920 0	two key set, length: 124 mm
Key set 55 OL-4	09260 6	four key set, length: 124 mm
Key set 55 OL-6	06890 8	six key set, length: 124 mm

The BURG-WÄCHTER safes of this series comply to the specifications of the european norm EN 1143-1 and/or EN 1047-1. This is approved by the **ECB-S** certificates of the European Certification Board • Security systems (Certification authorities according to EN 45001). The **ECB-S** certification includes multiple unannounced inspections of the production sites. Hereby a constant quality level is guaranteed. Errors and omissions excepted.



Concerns door dimensions H x W:
headroom door opening in mm

Subject to changes in sizes and colouring as well as technical improvements. Minor variations of sizes depend on production characteristics.

Safety cabinets OfficeLine



Office Line 111 - 116

RESISTANCE GRADE I

- freestanding safety cabinet/commercial freestanding safe
- type tested and supervised security by ECB-S!
- protected against burglary and fire
- body double-walled
- door double-walled
- solid three-sided locking through round bolts of 28 mm Ø, additional round dog bolts on hinge side
- prepared for floor fixing with fixing material
- depth for files of common size, adjustable shelves, also available with interior safe
- standard series version painted light grey RAL 7035, black front blind
- **additional feature:**
non-resettable emergency re-locking mechanism



Version S

Resettable, armoured high-security safe lock, "SecuSafe", ECB-S certified according to EN 1300 class B, with 2 keys, 10 levers, key captive, 50.000.000 key differs. The locking armature protrudes 20 mm.

More security in case of losing the key – immediately resettable to a new key.

Detailed information regarding the resettable high security safe lock TRS 22 see p. 100.

Art.-No.	EAN	Exterior H x W x D	Interior H x W x D	Door H x W	Weight	Volume
	40 03482...	mm	mm	Opening mm	kg	l
Office 111 S	30670 3	626 x 641 x 554	476 x 498 x 370	476 x 498	121	87
Office 112 S	30690 1	816 x 641 x 554	666 x 498 x 370	666 x 498	205	122
Office 114 S	30710 6	1096 x 641 x 554	946 x 498 x 370	946 x 498	213	174
Office 114 S 300	30790 8	1096 x 641 x 554	946 x 498 x 370	946 x 498	305	174
Office 116 S	30930 8	1486 x 780 x 554	1336 x 638 x 370	1336 x 638	310	315



Office 112 S



Version E

NEW: With integrated fingerscan-module in series. Detailed information about the biometric system see p. 99. Electronic combination lock "SecuTronic", VdS approved; ECB-S-certified according to EN 1300 class B. With intelligent menu-driven operation, administration of up to 10 user codes, up to 24 fingerscans and up to 300 optional TSE E-KEY. User names, access times and -rights, calendar functions, etc. via optional TSE PC-software packages programmable, see p. 29 + 31. Incl. 2 batteries Mignon LR 6 AA. The locking armature protrudes 50 mm.



Art.-No.	EAN	Exterior H x W x D	Interior H x W x D	Door H x W	Weight	Volume
	40 03482...	mm	mm	Opening mm	kg	l
Office 111 E	30660 4	626 x 641 x 554	476 x 498 x 370	476 x 498	121	87
Office 112 E	30680 2	816 x 641 x 554	666 x 498 x 370	666 x 498	205	122
Office 114 E	30700 7	1096 x 641 x 554	946 x 498 x 370	946 x 498	213	174
Office 114 E 300	30780 9	1096 x 641 x 554	946 x 498 x 370	946 x 498	305	174
Office 116 E	30940 7	1486 x 780 x 554	1336 x 638 x 370	1336 x 638	310	315



Office 114 E

Interior safe Office 111 - 116

It is also possible to assemble various interior safes one below the other.

Art.-No.	EAN	suitable for:	H x W x D
	40 03482...		mm
IT - Office 1	15230 0	Office 111 -114/300	151 x 498 x 303
IT - Office 2	15320 8	Office 116	151 x 638 x 303

Practical accessories for Office 111 - 114

Art.-No.	EAN	suitable for:
	40 03482...	
A-FB 100	04540 4	Office 111 -114/300 pull-out shelf Office
A-HR 100	04680 7	Office 111 -114/300 pull-out hanging frame Office

Optimal utilization of the Office Line interior space:

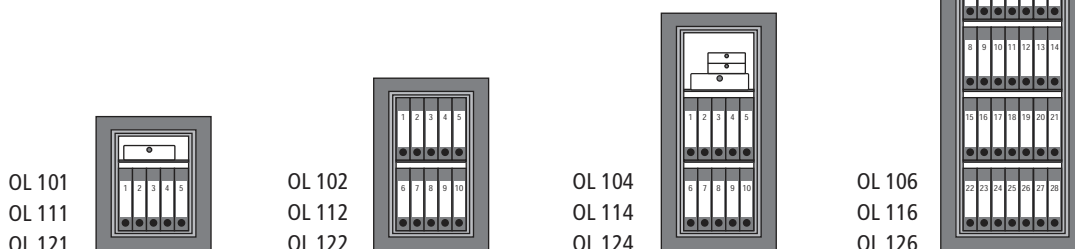

Office Line 121 - 126

RESISTANCE GRADE II

- freestanding safety cabinet/commercial freestanding safe
- type tested and supervised security by ECB-S!
- protected against burglary and fire
- body double-walled
- door double-walled
- solid three-sided locking through round bolts of 28 mm Ø, additional round dog bolts on hinge side
- prepared for floor fixing with fixing material
- depth for files of common size, adjustable shelves, also available with interior safe
- standard series version painted light grey RAL 7035, armature black
- **additional feature:**
non-resettable double emergency re-locking mechanism



Office 121 S



Version S

Resettable, armoured high-security safe lock, "SecuSafe", ECB-S certified according to EN 1300 class B, with 2 keys, 10 levers, key captive, 50.000.000 key differs. The locking armature protrudes 20 mm.

More security in case of losing the key – immediately resettable to a new key.

Detailed information regarding the resettable high security safe lock TRS 22 see p. 100.

Art.-No.	EAN	Exterior H x W x D	Interior H x W x D	Door H x W	Weight	Volume
	40 03482...	mm	mm	Opening mm	kg	l
Office 121 S	30020 6	626 x 641 x 554	476 x 498 x 370	476 x 498	205	87
Office 122 S	30040 4	816 x 641 x 554	666 x 498 x 370	666 x 498	205	122
Office 124 S	30060 2	1096 x 641 x 554	946 x 498 x 370	946 x 498	239	174
Office 126 S	30080 0	1486 x 780 x 554	1336 x 638 x 370	1336 x 638	336	315



Office 122 E



Version E

NEW: With integrated fingerscan-module in series. Detailed information about the biometric system see p. 99. Electronic combination lock "SecuTronic", VdS approved; ECB-S-certified according to EN 1300 class B. With intelligent menu-driven operation, administration of up to 10 user codes, up to 24 fingerscans and up to 300 optional TSE E-KEY. User names, access times and -rights, calendar functions, etc. via optional TSE PC-software packages programmable, see p. 29 + 31. Incl. 2 batteries Mignon LR 6 AA. The locking armature protrudes 50 mm.



Art.-No.	EAN	Exterior H x W x D	Interior H x W x D	Door H x W	Weight	Volume
	40 03482...	mm	mm	Opening mm	kg	l
Office 121 E	30030 5	626 x 641 x 554	476 x 498 x 370	476 x 498	205	87
Office 122 E	30050 3	816 x 641 x 554	666 x 498 x 370	666 x 498	205	122
Office 124 E	30070 1	1096 x 641 x 554	946 x 498 x 370	946 x 498	239	174
Office 126 E	30090 9	1486 x 780 x 554	1336 x 638 x 370	1336 x 638	336	315



Office 126 E

Interior safe for Office 121 - 126

It is also possible to assemble various interior safes one below the other.

Art.-No.	EAN	suitable for:	H x W x D
	40 03482...		mm
IT - Office 1	15230 0	Office 121 - 124	151 x 498 x 303
IT - Office 2	15320 8	Office 126	151 x 638 x 303

Practical accessories for Office 121 - 124

Art.-No.	EAN	suitable for:	
	40 03482...		
A-FB 100	04540 4	Office 121 -124	pull-out shelf Office
A-HR 100	04680 7	Office 121 -124	pull-out hanging frame Office



Key safes

The safety cabinets OfficeLine 104, 114 and 124 can be equipped as key safes on demand.

The interior contains 480 hooks fixed on 3 solid and free-moving completely extractable telescopic slide-outs.

Price and lead time on demand.

Fire Resistant Document Safes OfficeDoku



Office Doku 121 - 124

FIRE GRADE S 60 P AND RESISTANCE GRADE II

- document safe protection against burglary and fire
- fire protection: S 60 P (RAL-RG 626/7) (1 hour fire test for paper)
- 2 security grades in one, type tested and supervised burglary protection by ECB-S
- body double-walled
- door double-walled
- solid three-sided locking through round bolts of 28 mm Ø, additional round dog bolts on hinge side
- prepared for floor fixing with fixing material
- body with specially designed fire fold
- depth for files of common size, 2 adjustable shelves, also available with interior safe
- standard series version painted light grey RAL 7035, armature black
- **additional feature:** non-resettable double emergency re-locking mechanism



OfficeDoku 124 S



Version S

Resettable, armoured high-security safe lock, "SecuSafe", ECB-S certified according to EN 1300 class B, with 2 keys, 10 levers, key captive, 50.000.000 key differs. The locking armature protrudes 20 mm.

More security in case of losing the key – immediately resettable to a new key.

Detailed information regarding the resettable high security safe lock TRS 22 see p. 100.

Art.-No.	EAN	Exterior H x W x D	Interior H x W x D	Door H x W	Weight	Volume
	40 03482...	mm	mm	Opening mm	kg	l
OfficeDoku 121 S	30730 4	626 x 641 x 555	476 x 498 x 336	476 x 498	300	79,6
OfficeDoku 124 S	30770 0	1096 x 641 x 555	946 x 498 x 336	946 x 498	450	158,3



Version E

NEW: With integrated fingerscan-module in series. Detailed information about the biometric system see p. 99. Electronic combination lock "SecuTronic", VdS approved; ECB-S-certified according to EN 1300 class B. With intelligent menu-driven operation, administration of up to 10 user codes, up to 24 fingerscans and up to 300 optional TSE E-KEY. User names, access times and -rights, calendar functions, etc. via optional TSE PC-software packages programmable, see p. 29 + 31. Incl. 2 batteries Mignon LR 6 AA. The locking armature protrudes 50 mm.



Art.-No.	EAN	Exterior H x W x D	Interior H x W x D	Door H x W	Weight	Volume
	40 03482...	mm	mm	Opening mm	kg	l
OfficeDoku 121 E	30720 5	626 x 641 x 555	476 x 498 x 336	476 x 498	300	79,6
OfficeDoku 124 E	30760 1	1096 x 641 x 555	946 x 498 x 336	946 x 498	450	158,3



OfficeDoku 124 E

Interior safe for Office Doku 121 + 124

It is also possible to assemble various interior safes one below the other.

Art.-No.	EAN	suitable for:	H x W x D
	40 03482...		mm
IT - Office 1	15230 0	Office Doku 121 + 124	151 x 498 x 303

Key sets for OL 121+124 Doku

Detailed information regarding the resettable high security safe lock TRS 22 see p. 100.

Art.-No.	EAN	
	40 03482...	
Key set 55 GLK-2	09270 5	two key set, length: 162 mm, incl. hinge
Key set 55 GLK-4	09290 3	four key set, length: 162 mm, incl. hinge
Key set 55 GLK-6	06900 4	six key set, length: 162 mm, incl. hinge

The OfficeLine safety cabinets and fire resistant document safes with fingerscan-module in series.

Details see page 99.



The BURG-WÄCHTER safes of this series comply to the specifications of the european norm EN 1143-1 and/or EN 1047-1. This is approved by the **ECB•S** certificates of the European Certification Board • Security systems (Certification authorities according to EN 45001). The **ECB•S** certification includes multiple unannounced inspections of the production sites. Hereby a constant quality level is guaranteed. Errors and omissions excepted.



Disk safes SAFE-DIS 421 TE/422 TE

FIRE GRADE S 120 P AND RESISTANCE GRADE I

- fire protection: S 120 P (RAL-RG 626/7) (2 hours fire test for paper)
- with interior disk cabinet quality grade S 120 P/DIS
- fire-proof saving of documents **and** disks
- the perfect „cabinet in cabinet“ system
- colour: RAL 7035, light grey
- with electronic combination lock "SecuTronic",

- ECB-S certified according to EN 1300 class B
- 1.000.000 possible locking combinations
- exterior depth: handle protrudes 80 mm
- height from interior disk cabinet 918 mm respectively 1364 mm
- standard version with 2 possibilities for floor fixing



Safe-DIS 421 TE

Art.-No.	EAN	Exterior H x W x D	Interior H x W x D	Weight	Volume
	40 03482...	mm	mm	kg	l
Safe-DIS 421 TE	22600 1	1530 x 955 x 777	1268 x 734 x 440	650,0	409,0
Safe-DIS 422 TE	22610 0	1976 x 955 x 777	1714 x 734 x 440	850,0	553,0

SAFE-DIS 421/422 TE with fingerscan-module in series.

Details see page 99.



Accessories SAFE-DIS 421 TE/422 TE

Art.-No.	EAN	Description
	40 03482...	
421-10	22620 9	Partitioned shelf
421-30	22630 8	Telescopic pull-out partitioned shelf
421-50	22640 7	Telescopic pull-out hanging frame
421-70	22650 6	Interior safe, fire grade S 120 P/DIS

Disk safe SAFE-DIS 420 S

FIRE GRADE S 60 DIS

- fire protection: S 60 P (RAL-RG 626/7) (1 hour fire test)
- approved security according to RAL-RG 626/7
- the compact disk safe for every office with safety lock and practical springlock

- colour: RAL 7035, light grey
- exterior depth: handle protrudes 40 mm



Safe-DIS 420 S

Art.-No.	EAN	Exterior H x W x D	Interior H x W x D	Weight	Volume
	40 03482...	mm	mm	kg	l
Safe-DIS 420 S	24390 9	712 x 560 x 770	390 x 290 x 460	221,0	52,0

Accessories SAFE-DIS 420 S

Art.-No.	EAN	Description
	40 03482...	
420-35	24110 3	partitioned shelf
420-30	24070 0	telescopic pull-out partitioned shelf
420-64	24080 9	basket for 3 1/2" disks
420-74	24090 8	basket for 5 1/4" disks
430-90	24300 8	basket for streamer tapes



Disk safe SAFE-DIS 440 S – 446 S

FIRE GRADE S 120 DIS AND RESISTANCE GRADE II

- fire protection approved security according to RAL-RG 626/7 and 627 (2 hours fire test for disks)
- BURG-WÄCHTER disk safes with individual equipment
- gasproof and waterproof
- colour: RAL 7035, light grey
- exterior depth: locking armature protrudes 85 mm
- standard version with 2 possibilities for floor fixing
- **standard locking system:** resettable, armoured high-security safe lock "SecuSafe", ECB-S certified according to EN 1300 class B, 10 levers, key captive
- 50.000.000 key differs
- with automatic lock
- BURG-WÄCHTER "SecuTronic" (ECB-S certified according to EN 1300 class B) against surcharge



Art.-No.	EAN	Exterior H x W x D	Interior H x W x D	Weight	Volume
	40 03482...	mm	mm	kg	l
Safe-DIS 440 S	24400 5	730 x 786 x 918	332 x 446 x 478	320,0	71,0
Safe-DIS 441 S	24410 4	1050 x 786 x 918	652 x 446 x 478	460,0	139,0
Safe-DIS 442 S	24420 3	1293 x 786 x 918	895 x 446 x 478	543,0	191,0
Safe-DIS 444 S	24430 2	1850 x 786 x 918	1450 x 446 x 478	785,0	310,0
Safe-DIS 446 S	24440 1	1850 x 1193 x 918	1450 x 855 x 478	1150,0	590,0



Safe-DIS 441 E

Locking systems for disk safes SAFE-DIS 440 - 446

Lock class	Art.-No.	
S	2	1 safe lock (standard fitting)
E	2	NEW: With integrated fingerscan-module in series. Detailed information about the biometric system see p. 99. Electronic combination lock "SecuTronic", VdS approved; ECB-S-certified according to EN 1300 class B. With intelligent menu-driven operation, administration of up to 10 user codes, up to 24 fingerscans and up to 300 optional TSE E-KEY. User names, access times and -rights, calendar functions, etc. via optional TSE PC-software packages programmable, see p. 29 + 31. Incl. 2 batteries Mignon LR 6 AA. The locking armature protrudes 50 mm.



Safe-DIS 444 S

SAFE-DIS 440-446 E with fingerscan-module in series.

Details see page 99.

Equipped with the new locking system in course of this year.



Accessories SAFE-DIS 440 - 446

Art.-No.	EAN	Description
	40 03482...	
430-40	24210 0	partitioned shelf 440-444
434-60	24330 5	partitioned shelf 446
430-30	24170 7	telescopic pull-out partitioned shelf 440-444
434-67	24290 2	telescopic pull-out partitioned shelf 446
430-65	24180 6	basket for 3 1/2" disks (100 pcs. + 3 1/2" optical disk (60 pcs.)
430-75	24190 5	basket for CD-ROM (30 pcs) + 5 1/4" optical disk (30 pcs.)
430-90	24300 8	basket for Streamer Tapes
430-42	24230 8	adjustable partition for 430/30
434-42	24350 3	adjustable partition for 434-67
430-25	24240 7	interior safe for files for 440-444
434-25	24360 2	interior safe tray in two parts for 446



430-65



430-90